

# ***Nikon* XF Series Total Station**

## **Instruction Manual**

Part Number C301E1  
November 2017

***Nikon***

[www.trimble.com](http://www.trimble.com)

## Contact Information

Nikon Surveying Instruments  
10368 Westmoor Drive, Suite #100  
Westminster, CO 80021  
USA  
Phone: +1-720-587-4700  
888-477-7516 (Toll Free in U.S.)  
[sales@nikonpositioning.com](mailto:sales@nikonpositioning.com)

## Legal Notices

### Copyright and Trademarks

© 2007-2017, Nikon-Trimble Co. Limited. All rights reserved.  
All trademarks are the property of their respective owners.  
It is prohibited to alter this manual in part or whole without express permission.  
The contents of this manual are subject to change without notice.  
Although every effort has been made to ensure the accuracy of this manual, please contact your dealer if you find anything in it that is incorrect or unclear.

### Release Notice

This is the November 2017 release of the **Nikon XF Series Total Station Instruction Manual**, Revision B.

### Manufacturer

Nikon-Trimble Co., Ltd.  
Technoport Mituiseimei Bldg.  
16-2, Minamikamata 2-chome, Ota-ku  
Tokyo 144-0035 Japan

## Notices

### USA

FCC 15B Class B satisfied.

This equipment has been tested and found to comply with the limits for a Class B digital device, pursuant to Part 15 of the FCC Rules. These limits are designed to provide reasonable protection against harmful interference in a residential installation. This equipment generates, uses and can radiate radio frequency energy and, if not installed and used in accordance with the instructions, may cause harmful interference to radio communications. However, there is no guarantee that interference will not occur in a particular installation.

If this equipment does cause harmful interference to radio or television reception, which can be determined by turning the equipment off and on, the user is encouraged to try to correct the interference by one or more of the following measures:

- Reorient or relocate the receiving antenna.
- Increase the separation between the equipment and receiver.
- Connect the equipment into an outlet on a circuit different from that to which the receiver is connected.
- Consult the dealer or an experienced radio/TV technician for help.



**Warning** – This equipment has been certified to comply with the limits for a Class B personal computer and peripherals, pursuant to Subpart B of Part 15 of FCC Rules. Only peripherals (computer input/output devices, terminals, printers, etc.) certified to comply with the Class B limits may be attached to this equipment. Operation with non-certified personal computer and/or peripherals is likely to result in interference to radio and TV reception. The connection of a non-shielded equipment interface cable to this equipment will invalidate the FCC Certification of this device and may cause interference levels which exceed the limits established by the FCC for this equipment.

You are cautioned that changes or modifications not expressly approved by the party responsible for compliance could void your authority to operate the equipment.

## European Union

EU RE Directive satisfied.

### Authorized Representative in Europe

Trimble GmbH  
Am Prime Parc 11  
65479 Raunheim, Germany



### Canada

This Class B digital apparatus meets all requirements of the Canadian Interference-Causing Equipment Regulations.  
Cet appareil numérique de la Class B respecte toutes les exigences du Règlement sur le matériel brouilleur du Canada.

### Taiwan

#### Battery Recycling Requirements

The product contains a removable battery. Taiwanese regulations require that waste batteries are recycled.



### Notice to Our European Union Customers

For product recycling instructions and more information, please go to:  
[www.trimble.com/environment/summary.html](http://www.trimble.com/environment/summary.html)



### Recycling in Europe

To recycle Trimble WEEE, call: +31 497 53 2430, and ask for the “WEEE associate,” or mail a request for recycling instructions to:

Trimble Europe BV  
c/o Menlo Worldwide Logistics  
Meerheide 45  
5521 DZ Eersel, NL

### For Bluetooth unit

### USA

FCC Part 15 Subpart C/RSS-210, OET bulletin 65 supplement C satisfied



**Caution** – Any changes or modifications not expressly approved by the party responsible for compliance could void the user's authority to operate the equipment.

NOTE: This equipment has been tested and found to comply with the limits for a Class B digital device, pursuant to part 15 of the FCC Rules. These limits are designed to provide reasonable protection against harmful interference in a residential installation. This equipment generates, uses and can radiate radio frequency energy and, if not installed and used in accordance with the instructions, may cause harmful interference to radio communications. However, there is no guarantee that interference will not occur in a particular installation. If this equipment does cause harmful interference to radio or television reception, which can be determined by turning the equipment off and on, the user is encouraged to try to correct the interference by one or more of the following measures:

- Reorient or relocate the receiving antenna.
- Increase the separation between the equipment and receiver.
- Connect the equipment into an outlet on a circuit different from that to which the receiver is connected.
- Consult the dealer or an experienced radio/TV technician for help.

### Canada

RSS-210 Low Power Device

Operation is subject to the following two conditions: (1) This device may not cause interference, and (2) this device must accept any interference, including interference that may cause undesired operation of the device.

### European Union countries, Iceland, Norway, Liechtenstein, Turkey, Swiss

EN300 328 satisfied

Hereby, Nikon-Trimble Co., Ltd., declares the RE type Total station Nikon XS Series are in compliance with RED 2014/53/EU.

The full text of the EU DoC is available at the following internet address: <http://www.nikon-trimble.com/>

### RF exposure compliance

- 1) To comply with FCC/IC RF exposure compliance requirements, a separation distance of at least 20 cm must be maintained between the antenna of this device and all persons.
- 2) This transmitter must not be co-located or operating in conjunction with any other antenna or transmitter.

# Safety

## In this chapter:

- Introduction
- Warnings and Cautions
- Rechargeable Lithium-ion (Li-ion) batteries
- Laser Safety

## Introduction

For your safety, read this instruction manual carefully and thoroughly before using the Nikon XF Series Total Station. Although Nikon products are designed for maximum safety, using them incorrectly or disregarding the instructions can cause personal injury or property damage.

You should also read the documentation for any other equipment that you use with the instrument.

*Note* – Always keep the manual near the instrument for easy reference.

## Warnings and Cautions

The following conventions are used to indicate safety instructions:



---

**WARNING** – Warnings alert you to situations that could cause death or serious injury.

---



---

**CAUTION** – Cautions alert you to situations that could cause injury or property damage.

---

Always read and follow the instructions carefully.

### Warnings

Before using the instrument, read the following warnings and follow the instructions that they provide:



---

**WARNING** – Never look at the sun through the telescope. If you do, you may damage or lose your eyesight.

---



---

**WARNING** – The instruments are not designed to be explosion-proof. Do not use the instrument in coal mines, in areas contaminated with coal dust, or near other flammable substances.

---



---

**WARNING** – Never disassemble, modify, or repair the instrument yourself. If you do, you may receive electric shocks or burns, or the instrument may catch fire. You may also impair the accuracy of the instrument.

---



---

**WARNING** – Use **only** the battery charger and AC adapter that are supplied with the instrument. Do **not** use any other charger or you may cause the battery pack to catch fire or rupture.

---



---

**WARNING** – Do not cover the battery charger and AC adapter while the battery pack is being recharged. The charger must be able to dissipate heat adequately. Coverings such as blankets or clothing can cause the charger to overheat.

---



---

**WARNING** – Avoid recharging the battery pack in humid or dusty places, in direct sunlight, or near heat sources. Do not recharge the battery pack when it is wet. If you do, you may receive electric shocks or burns, or the battery pack may overheat or catch fire.

---



---

**WARNING** – Although the battery pack has an auto-reset circuit breaker, you should take care not to short circuit the contacts. Short circuits can cause the battery pack to catch fire or burn you.

---



---

**WARNING** – Never burn or heat the battery. Doing so may cause the battery to leak or rupture. A leaking or ruptured battery can cause serious injury.

---



---

**WARNING** – Before storing the battery pack or battery charger, cover the contact points with insulation tape. If you do not cover the contact points, the battery pack or charger may short circuit, causing fire, burns, or damage to the instrument.

---



---

**WARNING** – The battery is not itself waterproof. Do not get the battery wet when it is removed from the instrument. If water seeps into the battery, it may cause a fire or burns.

---

## Cautions

Before using the instrument, read the following cautions and follow the instructions that they provide:



---

**CAUTION** – Use of controls, adjustments, or performance of procedures other than those specified herein may result in hazardous radiation exposure.

---



---

**CAUTION** – The tops of the tripod ferrules are very sharp. When handling or carrying the tripod, take care to avoid injuring yourself on the ferrules.

---



---

**CAUTION** – Before carrying the tripod or the instrument in the carrying case, check the shoulder strap and its clasp. If the strap is damaged or the clasp is not securely fastened, the carrying case may fall, causing personal injury or instrument damage.

---



---

**CAUTION** – Before setting up the tripod, make sure that no-one's hands or feet are underneath it. When the legs of the tripod are being driven into the ground, they could pierce hands or feet.

---



---

**CAUTION** – After mounting the instrument on the tripod, securely fasten the thumb screws on the tripod legs. If the thumb screws are not securely fastened, the tripod may collapse, causing personal injury or instrument damage.

---



---

**CAUTION** – After mounting the instrument on the tripod, securely fasten the clamp screw on the tripod. If the clamp screw is not securely fastened, the instrument may fall off the tripod, causing personal injury or instrument damage.

---



---

**CAUTION** – Securely fasten the tribrach clamp knob. If the knob is not securely fastened, the tribrach may come loose or fall off when you lift the instrument, causing personal injury or instrument damage.

---



---

**CAUTION** – Do not stack objects on the plastic carrying case, or use it as a stool. The plastic carrying case is unstable and its surface is slippery. Stacking or sitting on the plastic carrying case may cause personal injury or instrument damage.

---



---

**CAUTION** – The system in the instrument may stop functioning in order to avoid any errors in measurement when the instrument detects strong electromagnetic wave(s). If this is the case, turn off the instrument and remove the source of the electromagnetic wave(s). Then turn on the instrument to resume the work.

---



---

**CAUTION** – Use the stylus provided with the instrument on the touch screen. Any other stylus may damage the touch screen.

---



---

**CAUTION** – *Lightly* tap the touch screen with the stylus. Otherwise, you may damage the touch screen.

---

## Rechargeable Lithium-ion (Li-ion) batteries



---

**WARNING** – Do not damage the rechargeable Lithium-ion battery. A damaged battery can cause an explosion or fire, and can result in personal injury and/or property damage.

To prevent injury or damage:

- Do not use or charge the battery if it appears to be damaged. Signs of damage include, but are not limited to, discoloration, warping, and leaking battery fluid.
  - Do not expose the battery to fire, high temperature, or direct sunlight.
  - Do not immerse the battery in water.
  - Do not use or store the battery inside a vehicle during hot weather.
  - Do not drop or puncture the battery.
  - Do not open the battery or short-circuit its contacts.
-



---

**WARNING** – Avoid contact with the rechargeable Lithium-ion battery if it appears to be leaking. Battery fluid is corrosive, and contact with it can result in personal injury and/or property damage.

To prevent injury or damage:

- If the battery leaks, avoid contact with the battery fluid.
  - If battery fluid gets into your eyes, immediately rinse your eyes with clean water and seek medical attention. Do not rub your eyes!
  - If battery fluid gets onto your skin or clothing, immediately use clean water to wash off the battery fluid.
- 



---

**WARNING** – Charge and use the rechargeable Lithium-ion battery only in strict accordance with the instructions. Charging or using the battery in unauthorized equipment can cause an explosion or fire, and can result in personal injury and/or equipment damage.

To prevent injury or damage:

- Do not charge or use the battery if it appears to be damaged or leaking.
  - Charge the Lithium-ion battery only in a product that is specified to charge it. Be sure to follow all instructions that are provided with the battery charger.
  - Discontinue charging a battery that gives off extreme heat or a burning odor.
  - Use the battery only in equipment that is specified to use it.
  - Use the battery only for its intended use and according to the instructions in the product documentation.
- 

## Laser Safety

Nikon XF Series is a Class 2 Laser Product in accordance with: IEC60825-1:2014: “Safety of Laser Products”

Precautions: To counteract hazards, it is essential for all users to pay careful attention to the safety precautions and control measures specified in the standard IEC60825-1:2014 within the *hazard distance* \*); particularly on to “User’s Guide”.

*Note* – This product complies with IEC 60825-1:2014 and IEC 60825-1:2007 and 21 CFR 1040.10 and 1040.11 except for deviations pursuant to Laser Notice no. 50. dated June 24, 2007.



---

**WARNING** – Only qualified and trained persons should be assigned to install, adjust and operate the laser equipment.

---



---

**WARNING** – Precautions should be taken to ensure that persons do not look directly, with or without an optical instrument, into the beam.

---



---

**WARNING** – Laser beam path should be located well above or below eye level wherever practicable.

---

---

**Nikon XF Series**

---

**Table 1.1 Specifications for laser emission****Laser pointer Class 2**

<b>Wave length</b>	630-680 nm
<b>Output power</b>	CW $P_o \leq 1 \text{ mW}$

**Disatance meter Class 1**

<b>Wave length</b>	850-890 nm
<b>Output power</b>	Pulse $P_o \leq 22 \text{ W}$
<b>Pulse width</b>	< 5 ns

**Laser plummet Class 2**

<b>Wave length</b>	635 nm
<b>Output power</b>	CW $P_o < 1.0 \text{ mW}$

---

**Table 1.2 Conforming standards**

<b>E.U.</b>	IEC60825-1:2014 Laser Pointer: Class 2 Distance Meter: Class 1 Laser plummet: Class 2
<b>USA</b>	FDA21CFR Part 1040 Sec.1040.10 and 1040.11 (except for deviations pursuant to Laser Notice No.50, dated June 24, 2007)

---



**Labels on the instrument**



**[1] Laser pointer**



**[2] Laser plummet**

(This label is attached when the instrument is laser plummet model.)



**[3] CFR**

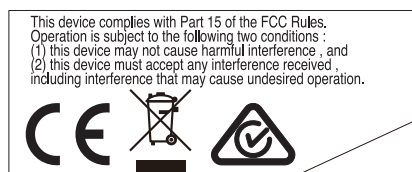

**[4] FCC**

**[1] Label for Laser pointer**



**[2] Label for Laser plummet (Laser plummet model)**

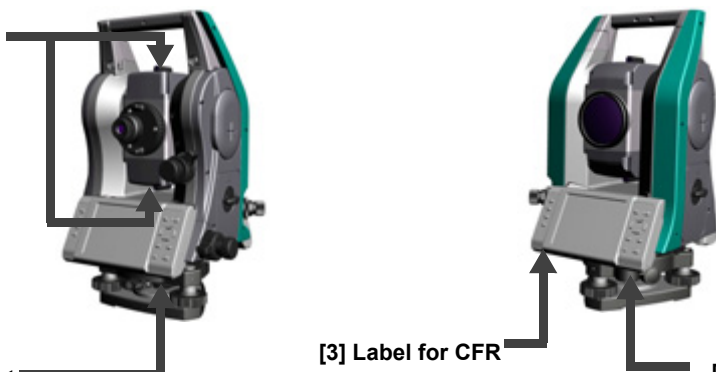

**[3] Label for CFR**



**[4] Label for FCC**



**Bluetooth**

**Class 1 Bluetooth 2.0 EDR+**

Frequency band: 2402 MHz to 2480 MHz

Maximum output power: > 10 mW

**WLAN**

**IEEE 802.11 b/g/n, Wi-Fi compliant**

Frequency: 2412 MHz to 2472 MHz

Output Power: < 80 mW



# Contents

- 1 Safety . . . . . iii**
  - Introduction . . . . . iv
  - Warnings and Cautions . . . . . iv
    - Warnings . . . . . iv
    - Cautions . . . . . v
  - Rechargeable Lithium-ion (Li-ion) batteries . . . . . vi
  - Laser Safety. . . . . vii
    - Bluetooth . . . . . ix
    - WLAN . . . . . ix
- 1 Introduction. . . . . 1**
  - Welcome . . . . . 2
  - Standard Components . . . . . 3
  - Parts of the Instrument . . . . . 4
  - Maintenance . . . . . 6
- 2 Preparation . . . . . 9**
  - Unpacking and Packing the Instrument . . . . . 10
    - Unpacking . . . . . 10
    - Packing . . . . . 10
  - Charging the Battery Pack . . . . . 10
  - Detaching and Re-Attaching the Battery Pack. . . . . 14
  - Setting Up the Tripod . . . . . 15
  - Centering . . . . . 15
    - Centering using the optical plummet . . . . . 15
    - Centering using the laser plummet . . . . . 16
    - Centering using a plumb bob . . . . . 17
  - Leveling . . . . . 17
  - Sighting and Focusing . . . . . 18
    - Sighting. . . . . 18
    - Auto Focusing . . . . . 19
  - Setting the Measurement Mode and Preparing the Target . . . . . 19
    - Measurement with a prism . . . . . 20
    - Measurement in Reflectorless mode . . . . . 21
  - Setting Up the Prism Reflector . . . . . 22
    - Adjusting the height of the tribrach adapter . . . . . 23
    - Changing the direction of the prism . . . . . 23
    - Setting the position of the target plate . . . . . 23
  - External Device Connector . . . . . 24
- 3 Getting Started . . . . . 27**
  - Turning the Instrument On and OFF . . . . . 28
    - Turning on the instrument . . . . . 28
    - Shutdown . . . . . 28
  - Basic Operation . . . . . 29
    - Standby . . . . . 29
    - Options . . . . . 29
    - Backlight . . . . . 29

	Auto power off setting . . . . .	.31
	Date/Time settings . . . . .	.32
	Security Settings. . . . .	.32
	Change PIN . . . . .	.32
	Get PUK . . . . .	.33
<b>4</b>	<b>Checking and Adjustment . . . . .</b>	<b>35</b>
	Adjusting the Electronic Level . . . . .	36
	Checking and Adjusting the Circular Level. . . . .	36
	Checking and Adjusting the Optical/Laser Plummet. . . . .	36
	Zero Point Errors of Vertical Scale and Horizontal Angle Corrections . . . . .	37
	Checking . . . . .	.37
	Adjusting . . . . .	.38
	Auto Focus Calibration . . . . .	43
	Checking the Instrument Constant. . . . .	44
	Checking the Laser Pointer . . . . .	45
<b>5</b>	<b>System Diagrams . . . . .</b>	<b>47</b>
	System Components . . . . .	48

# Introduction

## In this chapter:

- [Welcome](#)
- [Standard Components](#)
- [Parts of the Instrument](#)
- [Maintenance](#)

## Welcome

Thank you for purchasing this Nikon product.

This instruction manual was written for the users of the Nikon XF Series Total Station. Before you operate the instrument, read this manual carefully. In particular, pay attention to the warnings and cautions that appear in the Safety section at the front of the manual. Before you begin, you should also read the maintenance instructions. For more information, see [Maintenance, page 6](#).

## Standard Components

- Instrument main body
- Battery pack (x 2)
- Battery charger
- AC adapter
- Adjustment pin, Allen wrench
- Objective lens cap
- Rain/dust cover
- Carrying case
- Shoulder strap (x 2)
- USB cable

## Parts of the Instrument

Figure 1.1 and Figure 1.2 show the main parts of the instrument.

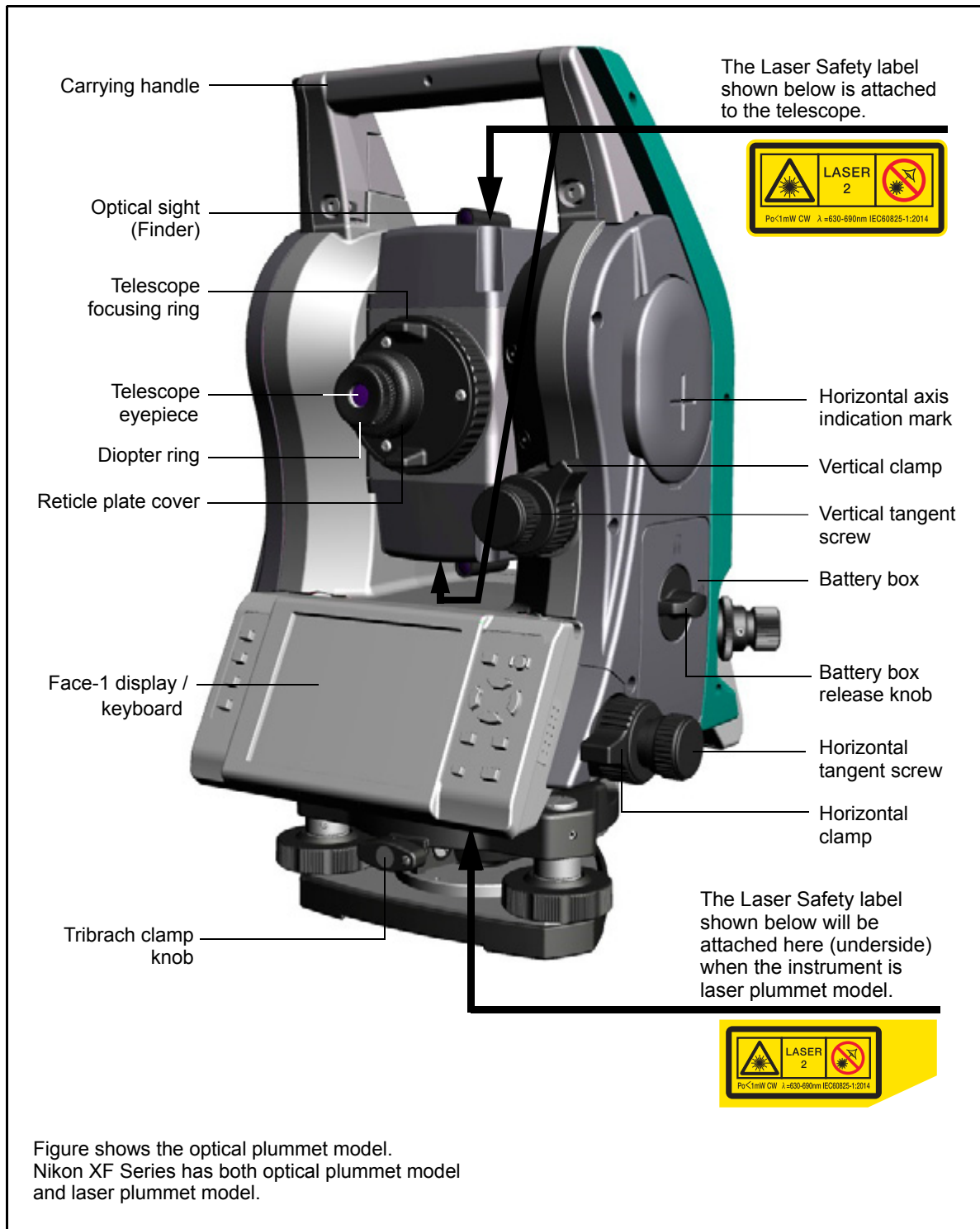

Figure 1.1 Nikon XF Series Total Station – Face-1



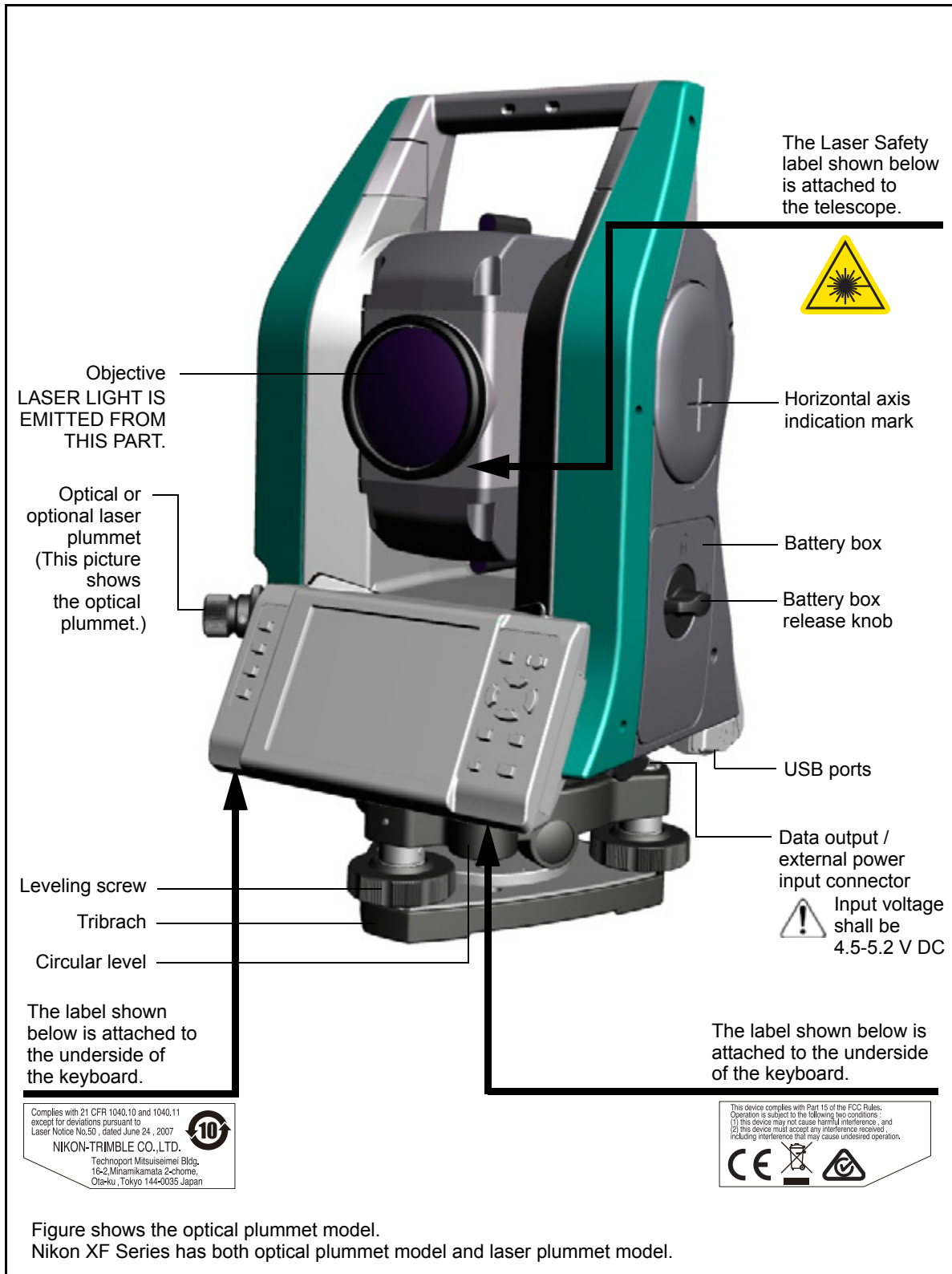

Figure 1.2 Nikon XF Series Total Station – Face-2

## Maintenance

Before using the instrument, read and follow the following maintenance instructions:

- Do not leave the instrument in direct sunlight or in a closed vehicle for prolonged periods. Overheating the instrument may reduce its efficiency.
- If the instrument has been used in wet conditions, immediately wipe off any moisture and dry the instrument completely before returning the instrument to the carrying case. The instrument contains sensitive electronic assemblies which have been well protected against dust and moisture. However, if dust or moisture gets into the instrument, severe damage could result.
- Sudden changes in temperature may cloud the lenses and drastically reduce the measurable distance, or cause an electrical system failure. If there has been a sudden change in temperature, leave the instrument in a closed carrying case in a warm location until the temperature of the instrument returns to room temperature.
- Do not store the instrument in hot or humid locations. In particular, you must store the battery pack in a dry location at a temperature of less than 30 °C (86 °F). High temperature or excessive humidity can cause mold to grow on the lenses. It can also cause the electronic assemblies to deteriorate, and so lead to instrument failure.
- Store the battery pack with the battery discharged.
- When storing the instrument in areas subject to extremely low temperatures, leave the carrying case open.
- When adjusting the leveling screws, stay as close as possible to the center of each screw's range. The center is indicated by a line on the screw.
- If the tribrach will not be used for an extended period, lock down the tribrach clamp knob and tighten its safety screw.
- Do not overtighten any of the clamp screws.
- When adjusting the vertical tangent screw and horizontal tangent screw, stay as close as possible to the center of each screw's range. The center is indicated by a line on the screw. For final adjustment of the tangent screws, rotate the screw clockwise.
- Do not use organic solvents (such as ether or paint thinner) to clean the non-metallic parts of the instrument (such as the keyboard) or the painted or printed surfaces. Doing so could result in discoloration of the surface, or in peeling of printed characters. Clean these parts only with a soft cloth or a tissue, lightly moistened with water or a mild detergent.
- To clean the optical lenses, lightly wipe them with a soft cloth or a lens tissue that is moistened with alcohol.

- The reticle plate cover has been correctly mounted. Do not release it or subject it to excessive force to make it watertight.
- Before attaching the battery pack, check that the contact surfaces on the battery and instrument are clean.
- Securely press the cap that covers the data output/external power input connector terminal. The instrument is not watertight if the cap is not attached securely, or when the data output/external power input connector is used.
- The carrying case is designed to be watertight, but you should not leave it exposed to rain for an extended period. If exposure to rain is unavoidable, make sure that the carrying case is placed with the Nikon nameplate facing upward.
- The battery pack contains a Lithium-ion battery. When disposing of the battery pack, follow the laws or rules of your municipal waste system.
- The instrument can be damaged by static electricity from the human body discharged through the data output/external power input connector. Before handling the instrument, touch any other conductive material once to remove static electricity.
- Be careful not to pinch your finger between the telescope and trunnion of the instrument.
- Use the stylus provided with the instrument on the touch screen. Any other stylus may damage the touch screen.
- Lightly tap the touch screen with the stylus. Otherwise, you may damage the touch screen.

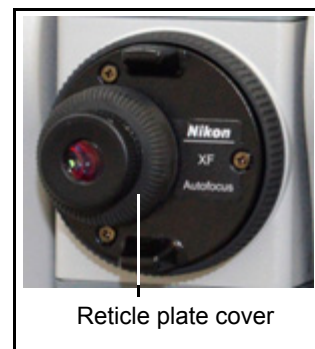



# Preparation

## In this chapter:

- Unpacking and Packing the Instrument
- Charging the Battery Pack
- Detaching and Re-Attaching the Battery Pack
- Setting Up the Tripod
- Centering
- Leveling
- Sighting and Focusing
- Setting the Measurement Mode and Preparing the Target
- Measurement in Reflectorless mode
- Setting Up the Prism Reflector
- External Device Connector

## Unpacking and Packing the Instrument

*Note – Handle the instrument gently to protect it from shocks and excessive vibration.*

### Unpacking

To unpack the instrument, grip the carrying handle and gently remove the instrument from the carrying case.

### Packing

To pack the instrument back into the carrying case, please refer to the figure on the inside of the case.



## Charging the Battery Pack

Before charging the battery pack, read the warnings (also listed in the Safety section at the front of this manual) and the following notes.



---

**WARNING –** Do not damage the rechargeable Lithium-ion battery. A damaged battery can cause an explosion or fire, and can result in personal injury and/or property damage.

To prevent injury or damage:

- Do not use or charge the battery if it appears to be damaged. Signs of damage include, but are not limited to, discoloration, warping, and leaking battery fluid.
  - Do not expose the battery to fire, high temperature, or direct sunlight.
  - Do not immerse the battery in water.
  - Do not use or store the battery inside a vehicle during hot weather.
  - Do not drop or puncture the battery.
  - Do not open the battery or short-circuit its contacts.
-



---

**WARNING** – Avoid contact with the rechargeable Lithium-ion battery if it appears to be leaking. Battery fluid is corrosive, and contact with it can result in personal injury and/or property damage.

To prevent injury or damage:

- If the battery leaks, avoid contact with the battery fluid.
  - If battery fluid gets into your eyes, immediately rinse your eyes with clean water and seek medical attention. Do not rub your eyes!
  - If battery fluid gets onto your skin or clothing, immediately use clean water to wash off the battery fluid.
- 



---

**WARNING** – Charge and use the rechargeable Lithium-ion battery only in strict accordance with the instructions. Charging or using the battery in unauthorized equipment can cause an explosion or fire, and can result in personal injury and/or equipment damage.

To prevent injury or damage:

- Do not charge or use the battery if it appears to be damaged or leaking.
  - Charge the Lithium-ion battery only in a product that is specified to charge it. Be sure to follow all instructions that are provided with the battery charger.
  - Discontinue charging a battery that gives off extreme heat or a burning odor.
  - Use the battery only in equipment that is specified to use it.
  - Use the battery only for its intended use and according to the instructions in the product documentation.
- 



---

**WARNING** – To charge the battery pack, use only the battery charger and AC adapter that are supplied with the instrument. Do not use any other charger or you may cause the battery pack to catch fire or rupture. The enclosed battery pack cannot be used with other chargers.

---



---

**WARNING** – Do not cover the battery charger and AC adapter while the battery pack is being recharged. The charger must be able to dissipate heat adequately. Coverings such as blankets or clothing can cause the charger to overheat.

---



---

**WARNING** – Avoid recharging the battery pack in humid or dusty places, in direct sunlight, or near heat sources. Do not recharge the battery pack when it is wet. If you do, you may receive electric shocks or burns, or the battery pack may overheat or catch fire.

---



---

**WARNING** – Although the battery pack has an auto-reset circuit breaker, you should take care not to short circuit the contacts. Short circuits can cause the battery pack to catch fire or burn you.

---



---

**WARNING** – Never burn or heat the battery. Doing so may cause the battery to leak or rupture. A leaking or ruptured battery can cause serious injury.

---



---

**WARNING** – Before storing the battery pack or battery charger, cover the contact points with insulation tape. If you do not cover the contact points, the battery pack or charger may short circuit, causing fire, burns, or damage to the instrument.

---



**WARNING** – The battery is not itself waterproof. Do not get the battery wet when it is removed from the instrument. If water seeps into the battery, it may cause a fire or burns.

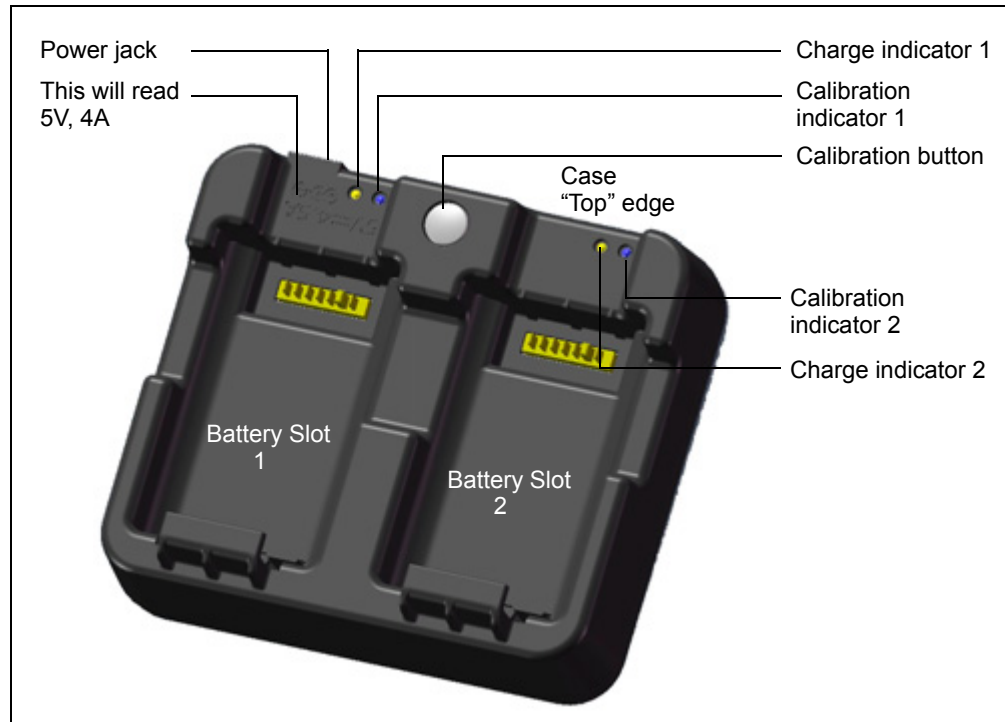

### Applying Power

- Plug in the charger to the supplied AC adapter to turn the unit on. The power input must be 5 V with at least 4 A of current capability. Each battery may take up to 2 A while charging.

### Charging a battery

- Simply slide a battery into either battery slot to begin charging. The adjacent charge indicator will illuminate yellow when charging is in progress. The charge indicator will change to green when charging is complete.
- Charger slots are completely independent so a battery may be inserted regardless of the state of the other battery slot.
- Charging may take 3-6 hours if the battery was normally discharged.
- Charging may take up to 7 hours with a completely drained battery which has been stored for several months without use.



- By design Li-Ion batteries should not be charged above 40 °C-45 °C so a blinking charge light may mean the batteries are too hot for charging. Charging will resume after the batteries cool down. The charging time will be longer due to the batteries cool down when charging batteries above 40 °C-45 °C.
- If the charge indicator(s) are blinking and the batteries feel cool, it may indicate a problem with the battery or the charger. If the charge light is still blinking after trying several batteries which are not warm, there is a problem with the unit or the batteries themselves.

### **Conditioning / calibrating a battery**

- Battery calibration is necessary about once every 6 months or more often if desired. Calibration ensures the reported battery charge remaining is accurate.
- Hold down the calibration button on the unit and then insert a battery while holding the calibration button to begin a battery calibration. Only the battery which was inserted while the button was depressed will begin calibration. During a battery calibration the battery will be charged, discharged completely, and then recharged before finishing. Calibration should complete in roughly 22 hours and the charger vents should not be covered during a calibration cycle.
- The blue calibration indicator light(s) will blink slowly (on 1.5 sec, off 2 sec) while a calibration is in progress and the charge light(s) may be on or off during the calibration cycle.
- When a calibration cycle is completed, the calibration light will stop blinking and remain on until the corresponding battery is removed.
- The bottom case temperature may continue to climb up to approximately 43 °C before temperature regulation is enabled to keep the case from getting warmer. As the battery voltage drops, the case will cool down and the automatic temperature limiting will no longer be necessary which minimizes the time it takes to discharge a battery.
- If the case temperature continues to get too hot internally even after temperature regulation is enabled, there is a secondary failsafe which will abort the calibration completely. If an abort occurs, the calibration light(s) will blink rapidly and battery charging will be re-enabled.

## Detaching and Re-Attaching the Battery Pack

### Detaching the battery pack



---

**CAUTION** – Avoid touching the contacts on the battery pack.

---

1. If the instrument is turned on, press **[PWR]** to turn it off.
2. Turn the battery box release knob counterclockwise, open the battery box cover and remove the battery pack from the battery box.

### Inserting the battery pack

Before inserting the battery pack, clear any dust or other foreign particles from the battery contacts.

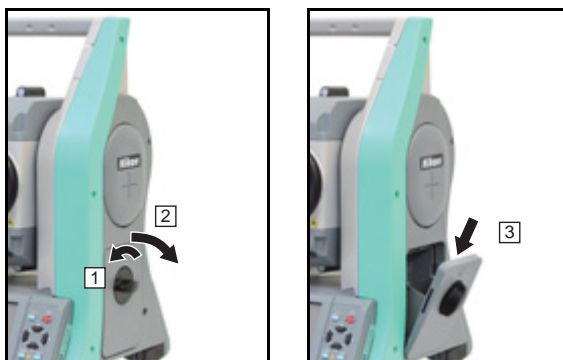

1. Turn the battery box release knob counterclockwise and open the battery box cover.
2. Put the battery pack into the battery box. Insert the battery pack with the connectors bottom first, facing inside.
3. Close the battery box cover and turn the knob clockwise until the secure click sound is heard.



---

**CAUTION** – If the battery box cover is not closed, this could adversely affect the watertightness of the instrument.

---

## Setting Up the Tripod



**CAUTION** – The tops of the tripod ferrules are very sharp. When handling or carrying the tripod, take care to avoid injuring yourself on the ferrules.

1. Open the tripod legs enough to for the instrument to be stable.
2. Locate the tripod directly over the station point. To check the tripod's position, look through the center hole in the tripod head.
3. Firmly press the tripod ferrules into the ground.
4. Level the top surface of the tripod head.
5. Securely fasten the thumb screws on the tripod legs.
6. Place the instrument on the tripod head.
7. Insert the tripod mounting screw into the center hole of the base plate of the instrument.
8. Tighten the tripod mounting screw.

*Note* – Do not carry the instrument while it is attached to a tripod.

## Centering

When you center the instrument, you align its central axis precisely over the station point. To center the instrument, you can either use the optical or laser plummet or a plumb bob.

### Centering using the optical plummet

*Note* – If you require high accuracy, check and adjust the optical plummet before you center the instrument. For detailed instructions, see [Checking and Adjusting the Circular Level, page 36](#).

To center the instrument using the optical plummet:

1. Set up the instrument on the tripod. For detailed instructions, see [Setting Up the Tripod, page 15](#).
2. While looking through the optical plummet, align the reticle with the station point. To do this, turn the leveling screws until the center mark  of the reticle is directly over the image of the station point.
3. While supporting the tripod head with one hand, loosen the tripod leg clamps and adjust the lengths of the legs until the air bubble is in the center of the circular level.
4. Tighten the tripod leg clamps.

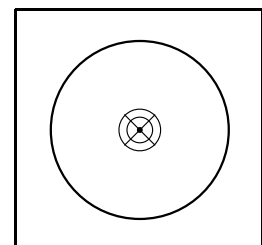

5. Use the electronic level to level the instrument. For detailed instructions, see [Leveling, page 17](#).
6. Look through the optical plummet to check that the image of the station point is still in the center of the reticle mark.
7. If the station point is off center, do one of the following:
  - If the station point is slightly off center, loosen the tripod mounting screw and then center the instrument on the tripod. Use only direct movement to center the instrument. Do not rotate it.  
  
When the instrument is centered, tighten the mounting screw.
  - If the displacement of the station point is major, repeat this procedure from Step 2.

### Centering using the laser plummet

*Note* – Do NOT look into the laser directly.

*Note* – If you require high accuracy, check and adjust the laser plummet before you center the instrument. For detailed instructions, see [Checking and Adjusting the Circular Level, page 36](#).

1. Set up the instrument on the tripod. For detailed instructions, see [Setting Up the Tripod, page 15](#).
2. Turn on the laser plummet.
3. Align the laser pointer to the station point. To do this, turn the leveling screws until the laser pointer is over the station point.
4. While supporting the tripod head with one hand, loosen the tripod leg clamps and adjust the lengths of the legs until the air bubble is the center of the circular level.
5. Tighten the tripod leg clamps.
6. Use the electronic level to level the instrument. For detailed instructions, see [Leveling, page 17](#).
7. Check the laser pointer is over the station point.
8. If the station point is off center, do one of the following:
  - If the station point is slightly off center, loosen the tripod mounting screw and then center the instrument on the tripod. Use only direct movement to center the instrument. Do not rotate it.
  - When the instrument is centered, tighten the mounting screw.
  - If the displacement of the station point is major, repeat this procedure from Step 2

## Centering using a plumb bob

1. Set up the instrument on the tripod. For detailed instructions, see [Setting Up the Tripod, page 15](#).
2. Hang the plumb line on the hook of the tripod mounting screw.
3. Adjust the length of the plumb line so that the tip of the plumb bob is at the height of the station point.
4. Loosen the tripod mounting screw slightly.
5. Using both hands to support the outer side of the tribrach, carefully slide the instrument about on the tripod head until the tip of the plumb bob is positioned over the exact center of the station point.

**Note** – To confirm that the instrument is precisely aligned, check its position from two directions at right angles to each other.

## Leveling

When you level the instrument, you make the vertical axis of the instrument exactly vertical. To level the instrument, use the electronic level. In the leveling work, always set the instrument in face 1 direction (please refer to the Fig.1.1 in page 3).

To level the instrument:

1. Move the bubble into the circle drawn on the circular level and then turn on the power.
2. Rotate the alidade until the bottom edge of the keyboard panel is parallel to the two of the leveling screws (B and C).
3. Use leveling screws B and C to move the bubble into the center of the electronic level.
4. Use leveling screw A to move the bubble into the center of the electronic level.
5. Repeat Step 2 through Step 4 to center the bubble.
6. Rotate the alidade 180°.
7. If the bubble in the electronic level remains centered, the instrument is level. If the bubble moves off center, adjust the electronic level. For detailed instructions, see [Adjusting the Electronic Level, page 36](#).

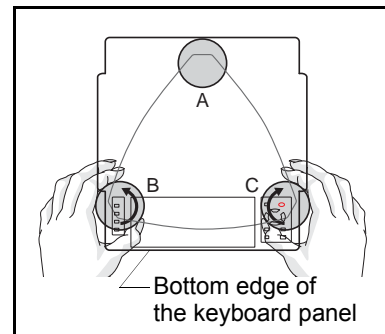

## Sighting and Focusing

### Sighting

When you sight the instrument, you aim the telescope at the target, bring the target image into focus, and align the image with the center crosshairs of the reticle.

To sight the instrument:

1. Adjust the diopter:
  - a. Aim the telescope at a blank area, such as the sky or a piece of paper.

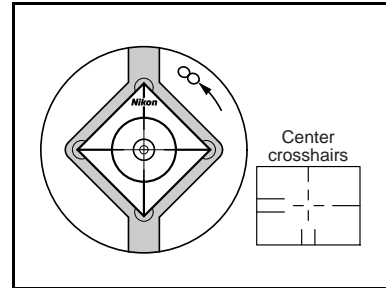

**WARNING** – Never look at the sun through the telescope. If you do, you may damage or lose your eyesight.

- b. Looking through the eyepiece, rotate the diopter ring until the reticle crosshairs are in sharp focus.
2. Eliminate parallax:
  - a. Aim the telescope at the target image.

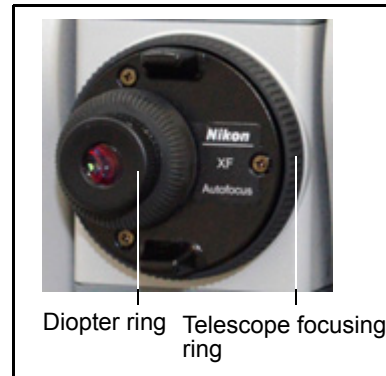

- b. Rotate the focusing ring until the target image is in sharp focus on the reticle crosshairs.
  - c. Move your eye vertically and laterally to check whether the target image moves relative to the reticle crosshairs.

If the target image does not move, there is no parallax.

- d. If the target image does move, rotate the telescope focusing ring. Then repeat from Step c.
3. Rotate the tangent screw:
  - The final turn of the tangent screw should be in a **clockwise** direction, to align the target accurately on the center crosshairs.
  - The focusing lens is driven by a motor when the telescope focusing ring is turned.

**Note** – To move the focusing lens, you need to power ON the instrument.

## Auto Focusing

Use autofocus to focus to a target automatically. First ensure AF is enabled within the onboard field software settings, then press **[AF]** key.

The Auto Focusing system focuses the lens using a distance captured by the EDM. At any time the manual focus ring can be used for precise adjustments to the focus.

The Auto Focusing system uses distance taken by EDM to drive the focusing lens to the appropriate position. Therefore, an EDM distance is required, if the instrument is to Auto Focus.

To best obtain the required distance for the EDM, rough sighting by optical sight (Finder) is needed.

The focusing is based on the center of the telescope (cross-hair sighting).

After turning the focusing ring, the instrument will remain in manual focusing mode until the **[AF]** key is next pressed.

## Setting the Measurement Mode and Preparing the Target

The Nikon XF Series has two measurement modes (Prism mode and Reflectorless mode), that can be selected by the installed application software.

To set the measurement mode depending on the target you want to measure, see the following table.

Target	Target setting
Prism, reflector sheet	Prism (Prism mode)
Other (reflective materials)	N-Prism (Reflectorless mode)

In some cases, you can measure another target that is not appropriate to the set measurement mode.

**Note** – Nikon XF Series is Laser Class 1 in the Prism and Reflectorless mode, and Laser Class 2 in Laser pointer function. Don't sight the Prism when the Laser Pointer is on.

### Measurement with a prism

Do not use a prism with scratches, a dirty surface, or a chipped center. Prisms with thin edges are recommended.

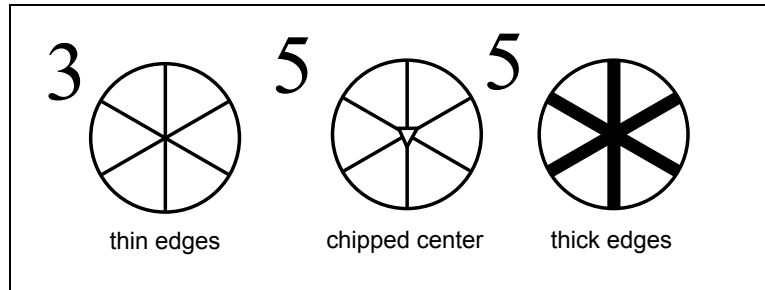

As the Nikon XF Series is extremely sensitive, multiple reflections on the prism surface can sometimes cause a significant loss in accuracy.

To maintain the accuracy of your measurements:

- When measuring a short distance, incline the prism slightly so that the EDM can ignore unnecessary reflections on the prism surface, as shown below.

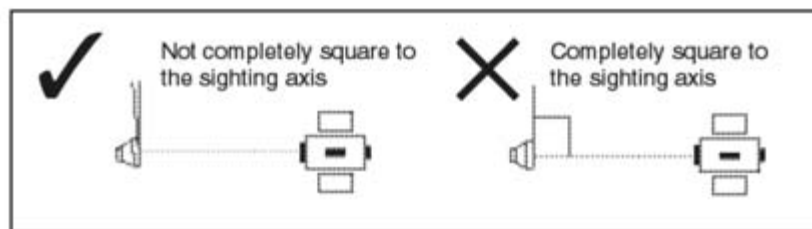

Hold the prism securely in place and do not move while taking measurements.

In Prism mode, in order to avoid false measurements on objects other than the prism or reflector-sheet, targets that are less reflective than the prism or reflector sheet are not measured. Even if measurement is started, measured values are not displayed. To measure less reflective objects, use the N-prism (reflectorless) mode



## Measurement in Reflectorless mode

The intensity of the reflection from the target determines the distance the Nikon XF Series can measure in this mode. The color and condition of the target surface also affect the measurable distance, even if the targeted objects are the same. Some less-reflective targets may not be measured.

Target	You can measure approximately...
Traffic signs, reflectors	800 meters (2624 feet)
Paper (white), veneer (new)	450 meters (1476 feet)
Wall (brightly painted), brick	150 to 300 meters (492 to 984 feet)

Measurable distances may be shorter or measurement intervals may be longer in the following cases:

- the angle of the laser against the target is small
- the surface of the target is wet

In direct sunlight, the measurable distance may be shorter. In this case, try to throw a shadow on the target.

Targets with completely flat surfaces, such as mirrors, cannot be measured unless the beam and the target are perpendicular to each other.

Make sure there are no obstacles between the instrument and the target when taking measurements. When you need to take measurements across a road or a place where vehicles or other objects are frequently moving, take several measurements to a target for the best result.

## Setting Up the Prism Reflector

1. Assemble the prism reflector as shown below.

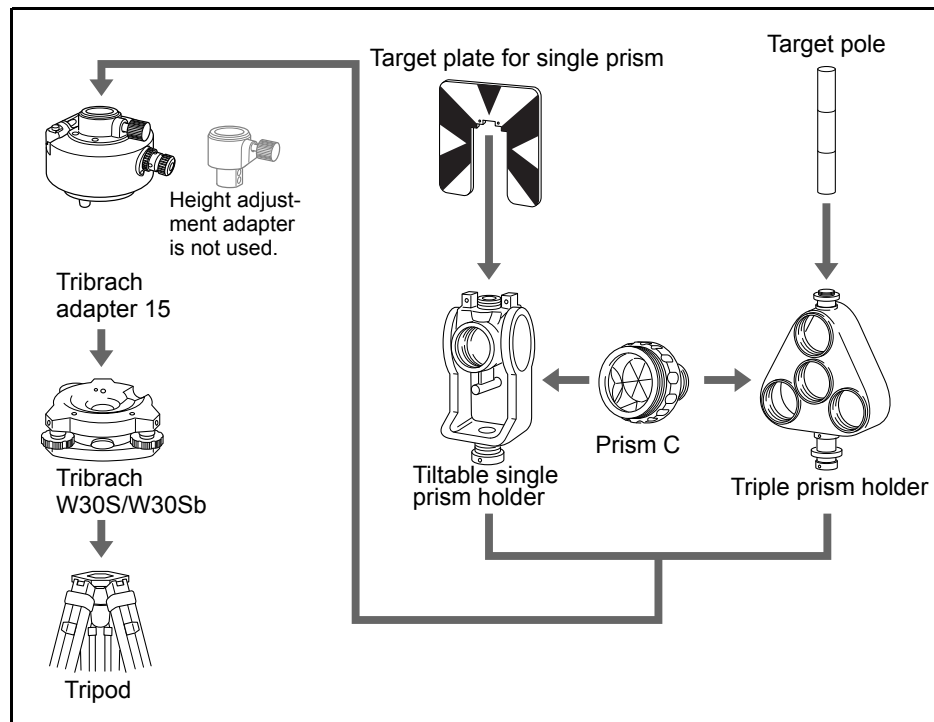

2. Adjust the height of the tribrach adaptor (see [page 23](#)).
3. If necessary, change the direction of the prism (see [page 23](#)).
4. If you are using a single prism holder, set the position of the target plate (see [page 23](#)).

Detailed instructions for Step 2 through Step 4 are provided on the following pages.

**Note** – The instrument must be used with the Tribrach W30S or W30Sb.

### Adjusting the height of the tribrach adapter

The tribrach adapter has a height adjustment adapter. To use the prism reflector with the instrument, remove the height adjustment adapter as shown in the Figure below.

The height adjustment adapter will be used with other Nikon Total Stations, except for Nivo Series, XS Series and XF Series.

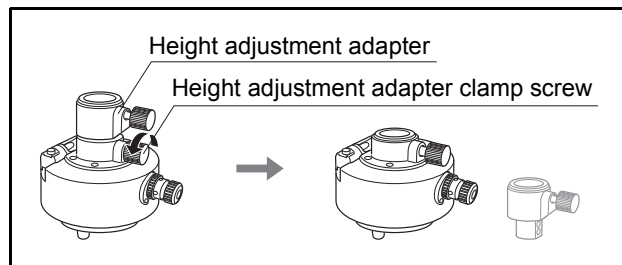

### Changing the direction of the prism

The prism mounted on the tribrach adapter can be rotated to face in any direction.

To change the direction of the prism:

1. Release the rotation clamp. To do this, turn the clamp lever counterclockwise.
2. Turn the upper plate of the tribrach adapter until the prism is facing in the required direction.
3. Fasten the rotation clamp. To do this, turn the clamp lever clockwise.

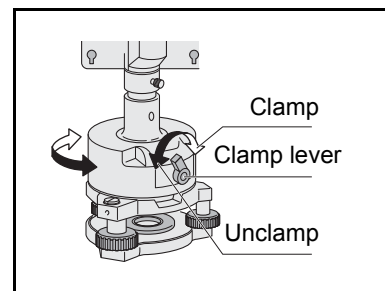

### Setting the position of the target plate

If using a single prism, make sure that the target plate is aligned with the tribrach adapter and the prism.

To set the position of the target plate:

1. Use the two set screws supplied to attach the target plate to the single prism holder.
2. Move the target plate within the screw holes until the apex of the wedge pattern is aligned with the vertical axis of the prism and the tribrach adapter.

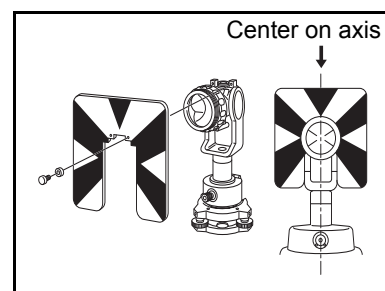

## External Device Connector

This connector can be used to connect to an external power source or to communicate with an external device.

Before using the external device connector, make sure that the external device meets the specifications below.

<b>Input voltage</b>	4.5 V to 5.2 V DC
<b>System</b>	RS-232C
<b>Signal level</b>	±9 V standard
<b>Maximum baud rate</b>	38400 bps asynchronous
<b>Compatible male connector</b>	Hirose HR10A-7P-6P or HR10-7P-6P



**CAUTION** – Except for the connection shown in Figure 5.1 on [page 48](#), use of this connector is at your own risk.



**CAUTION** – Use only the male connectors specified above. Using other connectors will damage the instrument.

The external device connector is a Hirose HR 10A-7R-6S female connector. The pinouts for connecting it to an external device connector are shown below:

Pin	Signal	Description
1	RXD	Receive data (Input)
2	TXD	Send data (Output)
3	NC	No connection
4	V	Power
5	GND	Ground
6	NC	No connection

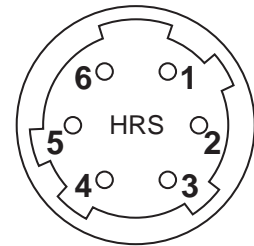

**CAUTION** – Use only the pin connections shown above. Using other connections will damage the instrument.



**CAUTION** – The Nikon XF and Nivo Series total station have different pin assignment from other models of Nikon total station.

To connect to an external power source, supply power to Pin 4 (power terminal) and Pin 5 (ground terminal) on the instrument. The instrument will use the external power source even if the internal battery packs are attached.



**CAUTION** – Make sure that the power supplied is within the rated input range (4.5 V to 5.2 V DC, 1 A maximum). Power supplied outside this range will damage the instrument.

To communicate with an external device, connect the RS-232C signal from the external device to Pin 1 (input terminal) and to Pin 2 (output terminal) on the instrument.

Cap the data output/external power input connector securely while not in use. The instrument is not watertight if the cap is not attached or not attached securely, and when the data output/external power input connector is in use.

The instrument can be damaged by static electricity from the human body discharged through the data output/external power input connector. Before handling the instrument, touch any other conductive material once to remove static electricity.



# Getting Started

## In this chapter:

- [Turning the Instrument On and OFF](#)
- [Basic Operation](#)
- [Security Settings](#)

## Turning the Instrument On and OFF

### Turning on the instrument

Press [Power] key to turn on the instrument, and the application program will start up.

Refer to the operation manual for how to use the application program.



***Note** – Check the batteries are correctly inserted into the slot if the application program doesn't start up even after pressing [power].*

### Shutdown

Press [Power] key, and the “Power Key!” window shown on the right appears.

Tap [Shutdown] button on the window to turn off the instrument.

***Note** – Executing Shut down ends the application program and the data that are not stored in the program will be lost.*





## Basic Operation

### Standby

Press [Power] key, and the “Power Key!” window shown on the right appears.

Tap [Standby] button on the window to turn off the instrument.

**Note** – “Standby” is the function which stops the program running and turns off the instrument. Pressing [Power] key again returns to the screen displayed before the instrument is turned off.



### Options

Press [Power] key, and the “Power Key!” window shown on the right appears.

Press [Options] button on the window to display option menu.

### Backlight

Tapping [Backlight On/Off] button on the option menu switches on/off the back light.

**Note** – Use the stylus provided with the instrument on the touch screen. Any other stylus may damage the touch screen.

**Note** – Lightly tap the touch screen with the stylus. Otherwise, you may damage the touch screen.

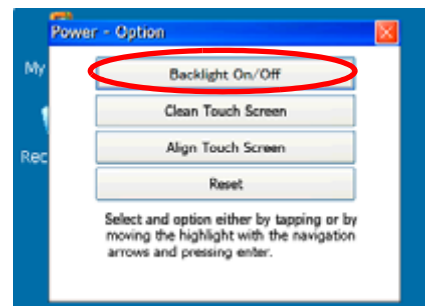

### Cleaning of touch screen

Tapping the menu button [Clean Touch Screen] disables the touch screen. Use this menu button for cleaning the touch panel.

Press ↵ (Enter) key, and the display returns to the screen shown before pressing [Power] key.

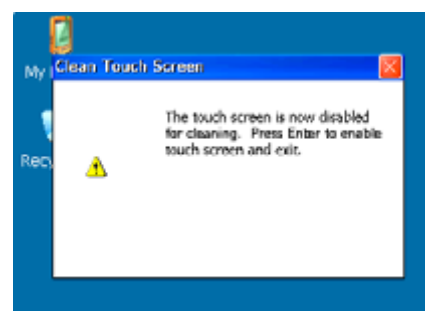

### Adjustment of touch screen

Tapping the menu button [Align Touch Screen] shows the touch panel adjustment window.

By following the instruction in this window, a gap between the actual tapping point and button on the window will be corrected.

Press [+] (plus) sign on the screen by stylus pen over 1 second. The [+] (plus) sign will move to a corner of the screen when you remove the stylus pen. Pressing ↵ (Enter) key after you press [+] (plus) sign on center and four corners completes the adjustment of touch screen.

Press [ESC] key to cancel the adjustment.



### Reset

Tap the menu button [Reset].

[Reset] stops the program in process and initializes the Total Station. Use this menu when the application program does not run normally because of an unexpected reason.

**Note** – *Once the Reset is executed, data that are not stored in the application program will be lost.*

## Auto power off setting

Auto power off function saves the consumption of electricity by switching the Total Station to the standby mode when it is not operated for a certain time.

1. Tap [Windows] button to display the menu.
2. Select [Settings] to display the sub-menu. Choose [Control Panel].
3. Double click [Power] icon. The latest battery status is displayed.
4. Choose [Power Off] tab. Time setting window is displayed.
5. Check the check box of [Suspend after] in the “Idle Time Settings” field.
6. Select time from the pull down menu.
7. Selectable time is 5/10/30 minutes. The suspend mode check box will be cleared if time is not selected from the pull down menu.
8. Tap [OK] button to complete the setting.



**Note** – Suspend mode and standby mode are the same status.

## Date/Time settings

This function allows date and time setting of the Total Station

1. Tap [Windows] button to display the menu.
2. Select [Settings] to display the sub menu.
3. Choose [Control Panel].
4. Double click [Date/Time] icon.
5. Current set date and time are displayed.
6. Set date, time and time zone.
7. Tap [Apply] button to fix the set values.
8. Tap [OK] button to complete the setting process.

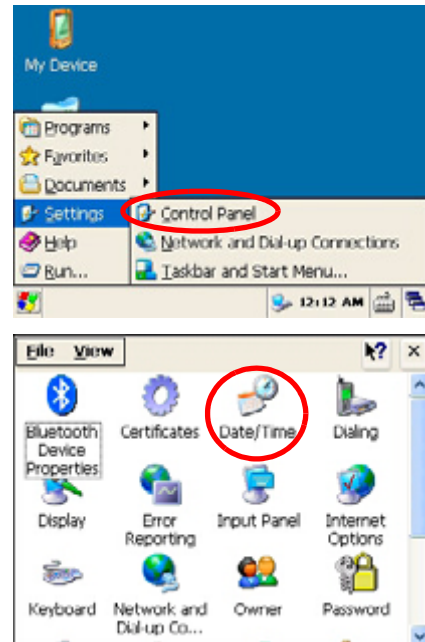

## Security Settings

Use the Security settings to avoid unauthorized use of the instrument, where a PIN/PUK security code can be activated and the PUK code will be displayed.

To enter the security settings program, tap [Windows] button to display the menu. Select [Program] to show the sub-menu. Choose [Security settings].

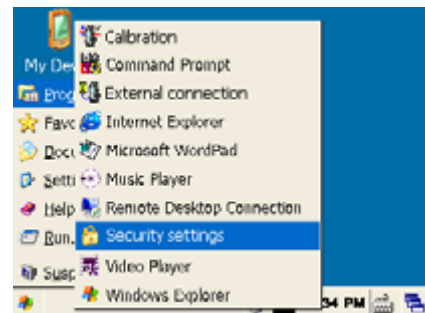

## Change PIN

1. To enable the security PIN Code or change the PIN Code, tap [Change PIN] on the security settings menu.
2. If the security PIN Code is already enabled, the current PIN Code needs to be entered.
3. Enter the current PIN Code and tap [Accept] button.
4. If you designate a new PIN Code, enter the new PIN Code, and press [←] or tap the next text box. To confirm the input, enter the same PIN Code, then tap [Accept] button.

The PIN Code is a four-digit number, e.g. “1234”. The default of PIN Code is “0000”. By default, the security setting is not enabled and you will not be prompted to enter the PIN Code when starting the work.

### **Get PUK**

To display PUK, tap [Get PUK] in the Security settings menu.

If the wrong PIN Code is entered more than ten times, you will be prompted to enter the PUK Code.

When the correct PUK Code has been entered, the PIN Code will be reset to “0000”. This means that the PIN Code security will be disabled. PIN Code security can be enabled again using the Change Pin instructions above.



# Checking and Adjustment

## In this chapter:

- [Adjusting the Electronic Level](#)
- [Checking and Adjusting the Circular Level](#)
- [Checking and Adjusting the Optical/Laser Plummet](#)
- [Zero Point Errors of Vertical Scale and Horizontal Angle Corrections](#)
- [Auto Focus Calibration](#)
- [Checking the Instrument Constant](#)
- [Checking the Laser Pointer](#)

## Adjusting the Electronic Level

Adjustment of the electronic level is done by Zero point errors of vertical scale and horizontal angle corrections. For detailed instruction, please see [page 37](#).

## Checking and Adjusting the Circular Level

Once you have checked and adjusted the electronic level, check the circular level.

If the bubble is not in the center of the level, use the adjusting pin to rotate the three adjustment screws of either circular level on the instrument main body or tribrach until the circular level of the instrument is centered.

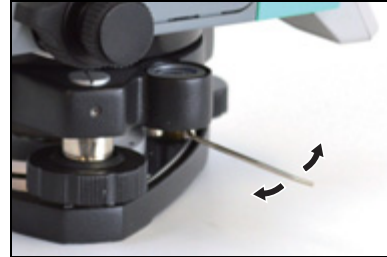

## Checking and Adjusting the Optical/Laser Plummet

The optical axis of the plummet must be aligned with the vertical axis of the instrument.

To check and adjust the optical/laser plummet:

1. Place the instrument on the tripod. You do not have to level the instrument.
2. Place a thick sheet of paper marked with an X on the ground below the instrument.

While you are looking through the optical plummet, adjust the leveling screws until the image of the X is in the center of the reticle mark .

For laser plummet, adjust the laser pointer to the X.

3. Rotate the alidade 180°.

If the marked image is in the same position in the center of the reticle mark, no adjustment is required

For laser plummet, if the laser pointer is on the X, no adjustment is required.

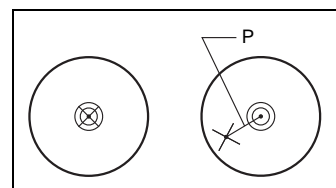



4. If the image or laser pointer is not in the same position, adjust the optical or laser plummet:
  - a. Use the supplied hexagonal wrench to turn the adjustment screws until the image of the X is in Position P. Position P is the center point of the line connecting the X and the center of the reticle mark .
  - b. Repeat from [Step 2](#). For laser plummet adjustment, a cap needs to be removed.

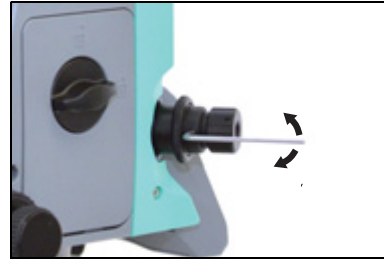

## Zero Point Errors of Vertical Scale and Horizontal Angle Corrections

Zero point of vertical angle scale and tilt sensor may be affected by long time storage, large temperature change, and shocks during transportation and in use. If the zero point offset occurs, it would introduce an error in measured data even if the instrument is properly setup. Manufacturer recommends periodical checking of several times per year.

### Checking

1. Set up the instrument on the tripod.
2. Follow the leveling procedures described in [Leveling, page 17](#).
3. Flip the telescope to the Face-1 position.
4. Sight a target that is within  $45^\circ$  of the horizontal plane.
5. Read the vertical angle from the VA1 field in the Basic Measurement Screen (BMS).
6. Rotate the instrument  $180^\circ$  and flip the telescope to the Face-2 position.
7. Read the vertical angle from the VA2 field.
8. Add the two vertical angles together,  $VA1 + VA2$ .
  - No adjustment is required if the zero reference for vertical angles (VA zero setting) is set to Zenith, and  $VA1 + VA2$  equals  $360^\circ$ .
  - No adjustment is required if the zero reference for vertical angles (VA zero setting) is set to Horizon, and  $VA1 + VA2$  is either  $180^\circ$  or  $540^\circ$ .
  - An adjustment is required if  $VA1 + VA2$  is not one of the values listed above.

**Note** – The difference between the vertical angle reading the relevant angle (either  $360^\circ$  for Zenith, or  $180^\circ$  or  $540^\circ$  for Horizon) is called the **altitude constant**.

## Adjusting

There are two steps in the calibration program. Usually you only complete the first step that is described below, because the trunnion axis is finely adjusted mechanically.

To make a major adjustment to the trunnion axis error compensation, however, you can complete the second step that is described below and make three sets of observations.

To set the parameters for trunnion axis error compensation, establish two targets at a horizontal distance of at least 30 m from the instrument. The first target should be placed on the horizontal plane and the second should be more than 30° above the horizontal plane. Before you set the trunnion axis compensation value, you must complete three sets of F1/F2 observations to these two points. Even if you complete the second step, the instrument cannot store a trunnion axis error compensation of more than 30". If the error is more than 30", the instrument needs a mechanical check.

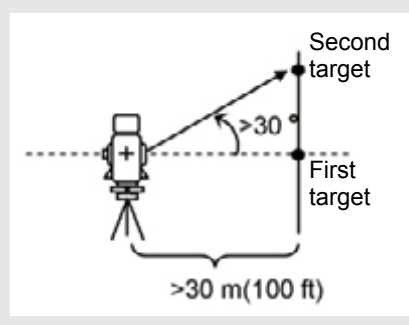

To enter the calibration program, tap *Windows* button to display the menu. Select *Program* to show the sub-menu. Choose *Calibration*.

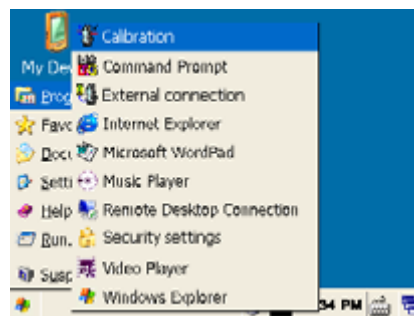

### First step

1. Tap [VA0/HA/Tilt].

Take an F1 measurement to a target on the horizon. Tap **OK**.

The vertical angle is shown in the V0 dir= Horiz setting.

- VA1 Face-1 vertical angle (tilt-off value)
- HA1 Face-1 horizontal angle (tilt-off value)
- X1 Face-1 X axis tilt value
- Y1 Face-1 Y axis tilt value

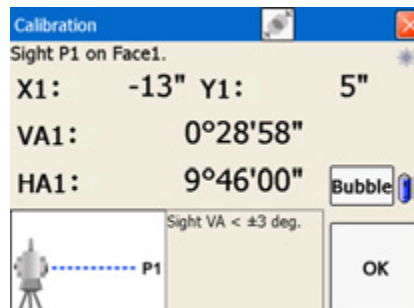
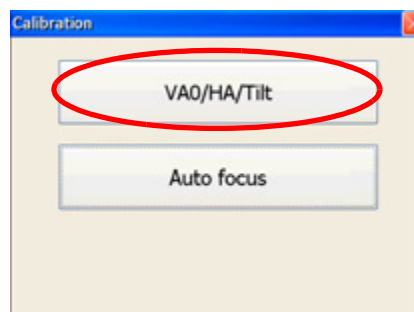

If you sight a target that has a VA of more than 3°, a warning message appears and **OK** button becomes disabled.

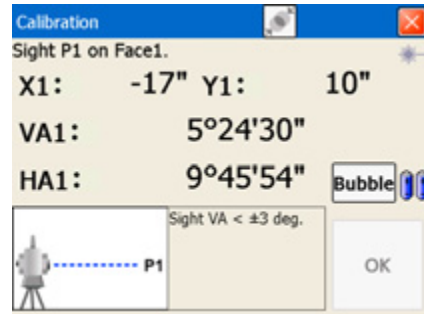

When you have taken the measurement, the message changes from **DO NOT TOUCH!** to **Turn to F2.**

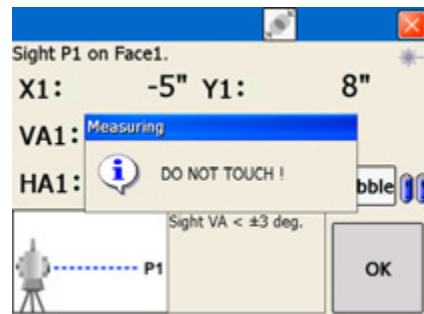

2. Take an F2 measurement to the same target. Tap **OK**.

- VA2 Face-2 vertical angle (tilt-off value)
- HA2 Face-2 horizontal angle (tilt-off value)
- X2 Face-2 X axis tilt value
- Y2 Face-2 Y axis tilt value

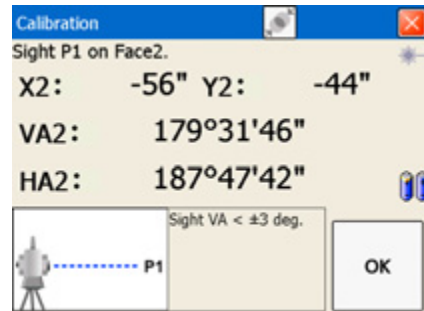
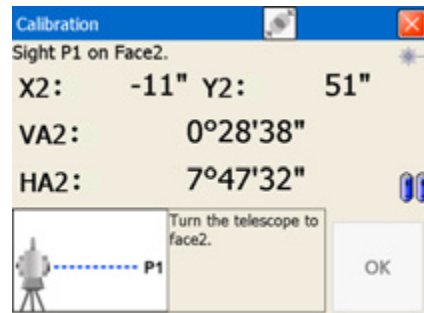

When the observation on F2 is completed, three parameters are displayed.

3. Do one of the following:
  - To return to the first observation screen, tap **Redo**.
  - To set parameters on the instrument, tap **OK**.

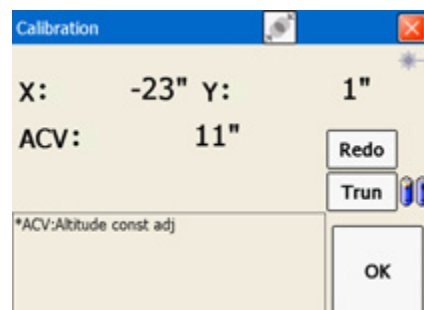

4. To go to the second step (trunnion axis compensation), tap **Trun**.

If the HA corr. setting is set to OFF, the ACH parameter is not applied to horizontal angle readings. If this setting is set to ON, both of the ACH and trunnion-axis parameters are applied to HA. If you do not complete the second step, the trunnion-axis parameter remains set to zero, and only the ACH parameter is applied. If ACV, ACH, X, or Y is out of range, OVER appears. Press any key to return to the first observation screen.

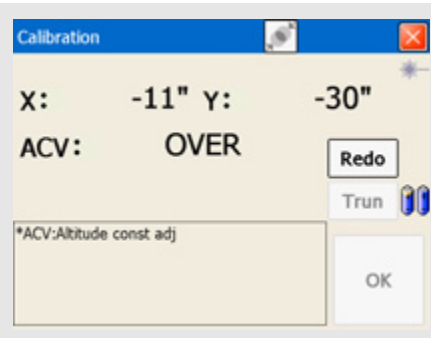

### Second step

1. Sight the second target that is placed more than 30° above the horizontal plane.
2. Tap **OK** to take angle measurements in the following order:
  - Face-2 to P2
  - Face-1 to P2
  - Face-1 to P1 (Horizontal)
  - Face-2 to P1 (Horizontal)
  - Face-2 to P2
  - Face-1 to P2
  - Face-1 to P1 (Horizontal)
  - Face-2 to P1 (Horizontal)
  - Face-2 to P2
  - Face-1 to P2

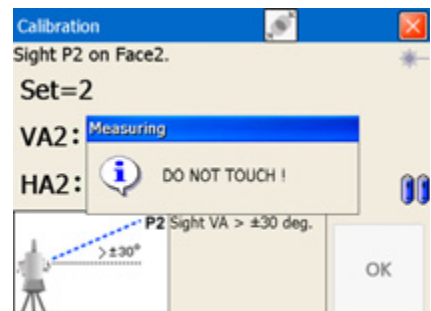
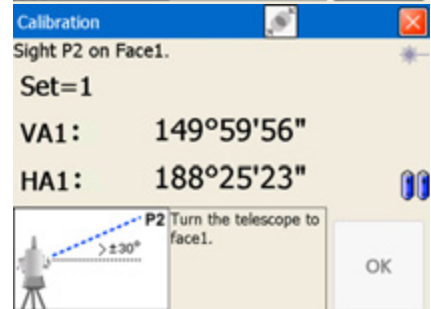
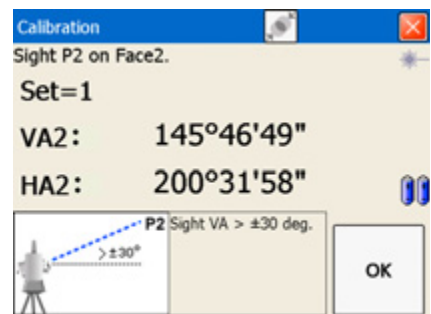

The tolerance in angle reading to each direction is 10". To maintain the accuracy of the instrument, you must take shots with extreme care. If the dHA to the same direction is more than 10", an error message appears, and you must remeasure all three sets of points.

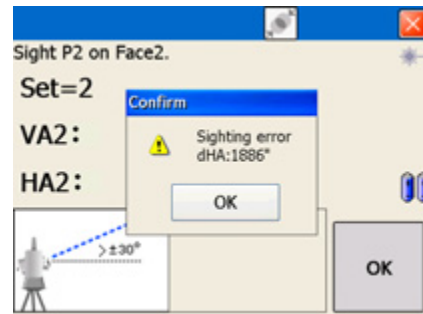

After three sets of F1/F2 observations, the instrument calculates the trunnion axis parameter and the updated ACH (the average of each set).

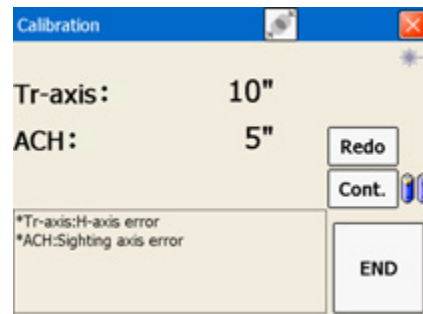

3. Do one of the following:
  - To return to the measurement screen for the first set of F1 measurements, tap **Redo**.
  - To go to the next set of observations for a more accurate result, tap **Cont.** You can record up to ten sets.
  - To store the parameter and return to the BMS, tap **End**.
4. If HA corr. is set to OFF when you finish updating the trunnion axis parameter, a message appears. The message asks if you want to change the setting. To change the setting, tap **Yes**.

### Trunnion axis compensation

The trunnion axis error is reported when the vertical axis and the trunnion axis (horizontal axis) are not perpendicular to each other. The sighting axis error is from the sighting and the trunnion axes. These two errors can be compensated by applying the Tr-axis and ACH parameters on this instrument to horizontal angle readings.

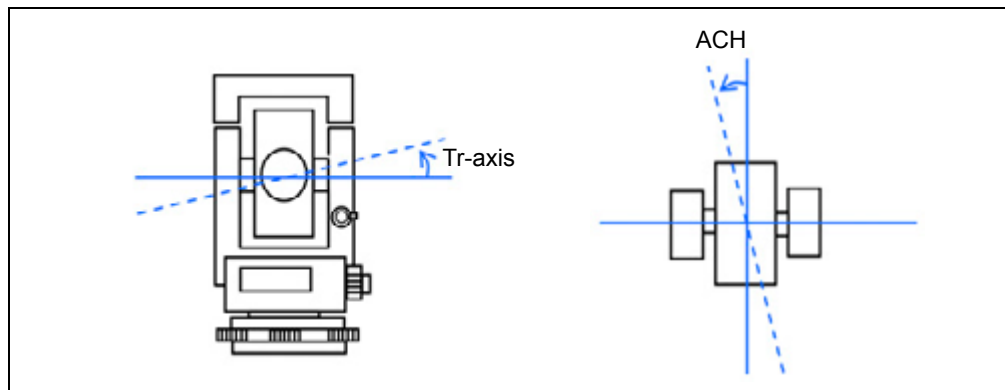

Because the amount of compensation changes according to the vertical angle, when compensation is enabled there is a slight movement in horizontal angle even if you clamp the tangent screw.

## Auto Focus Calibration

To calibrate Auto Focus, tap **Auto Focus** in the **Calibration** menu.

1. Sight a non-prism point that is between 2 m and 4 m away and focus manually using the focus ring. Then press **[+]** or **[-]** button to fine adjust the focus.
2. Once fine adjustment is complete, tap **MSR**.

*Note – The MSR button is enabled after tapping **[+]** or **[-]** button, and disabled after moving the focus ring.*

*When the MSR key is pressed, a distance measurement is started using reflectorless precise mode.*

3. After measuring the near point, sight a non-prism point at least 100 m away, and follow the same focusing procedure as above: first using the focus ring, then **[+]** or **[-]** button, for fine adjustment. Then measure the distance by tapping **MSR**.

4. Once both the near and far measurements are complete, the calibration constant will be calculated. If the calibration is successful, the following screen will be displayed.

Tap **OK** for saving the constant and return to the *Calibration* menu.

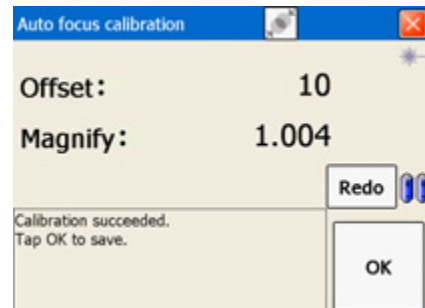
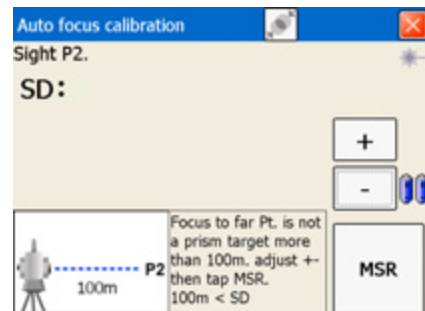
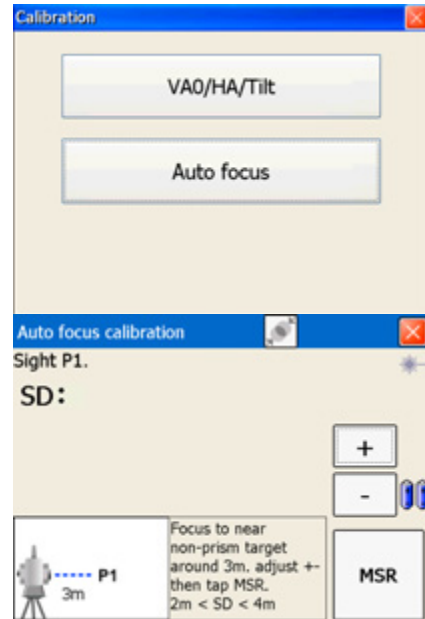

## Checking the Instrument Constant

The instrument constant is a numerical value used to automatically correct for the displacement between the mechanical and electrical centers when measuring distances. The instrument constant is set by the manufacturer before the instrument is shipped. However, to ensure the highest operational accuracy, we recommend that you check the instrument constant several times a year.

To check the instrument constant, you can either compare a correctly measured base line with the distance measured by the EDM, or follow the procedure below.

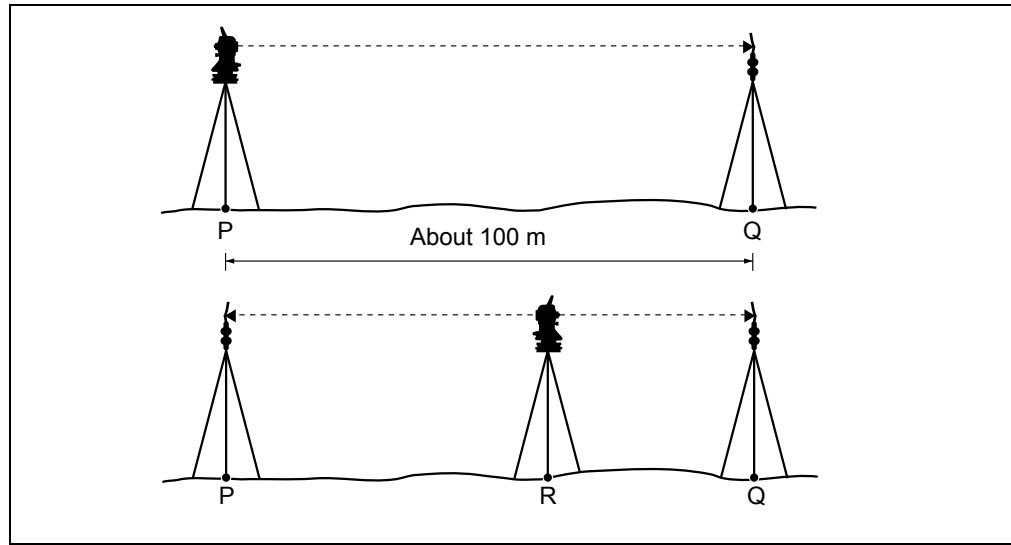

1. Set up the instrument at Point P, in as flat an area as possible.
2. Set up a reflector prism at Point Q, 100 m away from Point P. Make sure that you take the prism constant into account.
3. Measure the distance between Point P and Point Q (PQ).
4. Install a reflector prism on the tripod at Point P.
5. Set up another tripod at Point R, on the line between Point P and Point Q.
6. Transfer the instrument to the tripod at Point R.
7. Measure the distance from Point R to Point P (RP), and from Point R to Point Q (RQ).
8. Calculate the difference between the value of PQ and the value of RP + RQ.
9. Move the instrument to other points on the line between Point P and Point Q.
10. Repeat [Step 5](#) through [Step 9](#) ten times or so.
11. Calculate the average of all the differences.

The error range is within 3 mm. If the error is out of range, contact your dealer.



## Checking the Laser Pointer

The Nikon XF Series total station laser pointer is a red laser beam. The laser pointer is coaxial with the line of sight of the telescope. If the instrument is well adjusted, the red laser pointer coincides with the line of sight. External influences such as shock or large temperature fluctuations can displace the red laser pointer relative to the line of sight.



# System Diagrams

In this chapter:

- [System Components](#)

## System Components

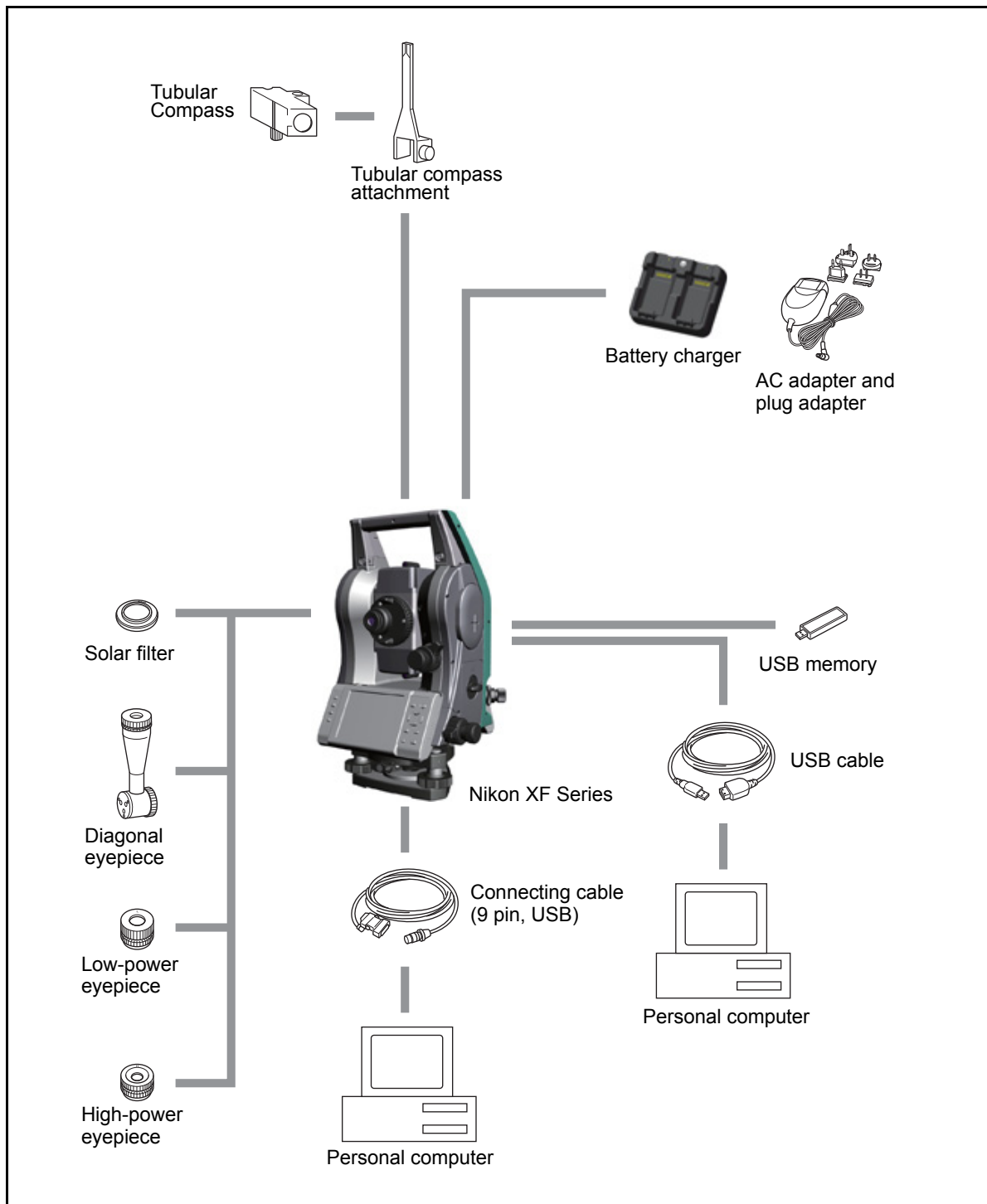

Figure 5.1 Measurement side

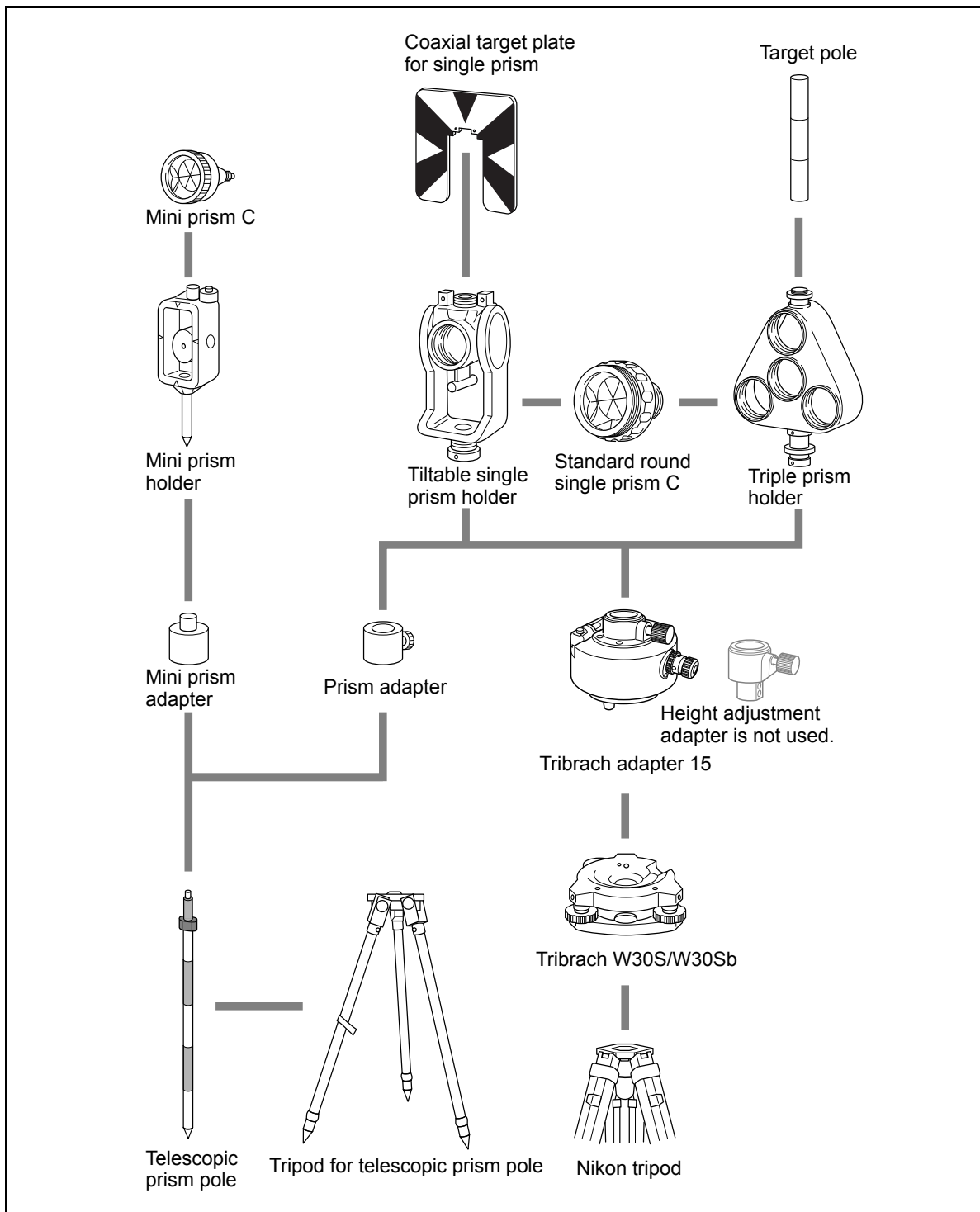







Figure 5.2 Prism reflector side

**Note** – Nikon XF Series must be used with the Tribrach W30S or W30Sb.



Appendix: XF Series 全站仪相关产品的有毒有害物质及元素的名称,含有量,环保使用期限

环保使用期限	部件名称	有毒有害物质及元素					
		铅 (Pb)	水银 (Hg)	铬 (Cd)	六价铬 (Cr <sup>+6</sup> )	PBB (PBB)	PBDE (PBDE)
	全站仪本体						
	1) 外壳 (金属制)	×	○	○	○	○	○
	外壳 (塑胶制)	○	○	○	○	○	○
	2) 基座/构机部	×	○	○	○	○	○
	3) 光学镜片/棱镜/滤光镜片	○	○	○	○	○	○
	4) 电气实装部 (包括电子部品)	×	○	○	○	○	○
	5) 其他金属部品	×	○	○	○	○	○
	充电器 ※1						
	1) 充电器本体	×	○	○	○	○	○
	2) AC适配器	×	○	○	○	○	○
	3) 连接导线类	×	○	○	○	○	○
	电池部 ※1						
	电池单品 (Li-ion)	×	○	○	○	○	○
	CD-ROM (使用说明书)	○	○	○	○	○	○

备注:

- 关于有毒有害物质及元素的表示  
 ○: 该部品所有均质材料的有毒有害物质含有量,不可超过GB/T26572标准所规定的限量要求  
 ×: 该部品中至少有一项均质材料的有毒有害物质含有量,超过GB/T26572标准所规定的限量要求  
 只是其中的任何一项在现在的技术水平下,要转换成不含有有毒有害物质,非常的困难。  
 符合「关于电气电子特定有害物质的使用限制的指令2011/65/EU」中所指定的除外项目
- 关于充电器(连接导线类),电池(※1)  
 充电器(连接导线类),电池有和主产品一起出售,也有单独出售的,含有成分相同。
- 本说明书作为使用说明书的一部分,分开印刷。

环保使用期限

此标志的数字是根据中华人民共和国电子信息产品污染控制管理办法以及有关标准等,表示该产品环保使用期限的年数。遵守产品的安全和使用上的注意,在产品使用后采取适当的方法根据当地的法律,规定,回收再利用或进行废弃处理。



这些标志是面向中国客户,在电子信息产品领域,保护环境的标识。

These marks are for users in China, and indicate to protect environment in using the electronic information products.

**CONTACT DETAILS**

10368 Westmoor Drive, Suite #100  
Westminster, Colorado 80021  
USA

888-477-7516 (Toll Free)  
1-720-587-4700 Phone

**[www.spectraprecision.com](http://www.spectraprecision.com)**

For sales information and dealer locator:  
[sales@nikonpositioning.com](mailto:sales@nikonpositioning.com)

**[www.trimble.com](http://www.trimble.com)**